

**MORSETOS PARA HILO DE GUARDIA**  
(GROUND WIRE CLAMPS)

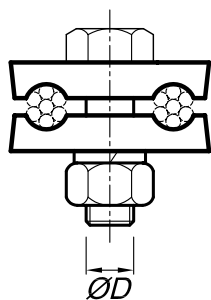

Fig.1

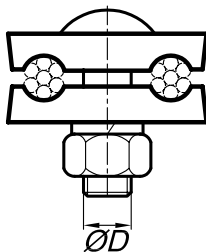

Fig.2

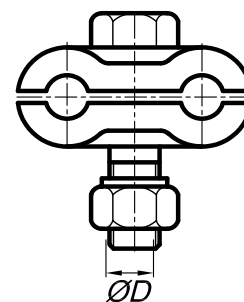

Fig.3

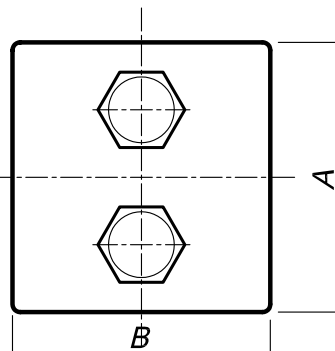
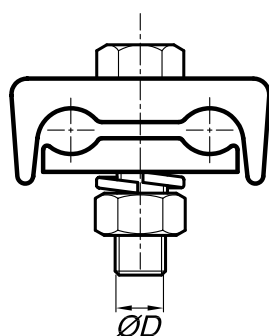
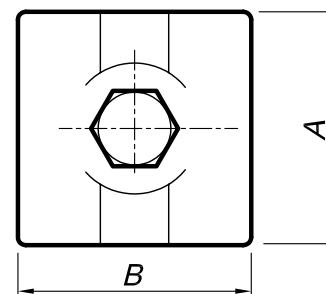
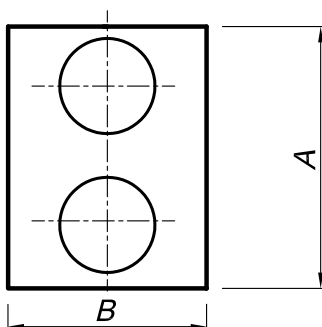
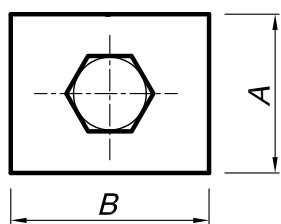

Fig.4

Modelo (Model)	Dimensiones (Dimensions) mm					Material (Material)
	Alcance (Range)	A	B	ØD	Fig.	
M8-A	Ø 6 a 8	35	41	9,5	1	Fund. nodular Galv. en caliente
M8-B	Ø 8 a 11	40	50	12,7	1	
M8-C	Ø 10 a 12,5	59	58	12,7	3	
M6-A	Ø 6 a 8	52	42	9,5	2	Ductil Iron Hot dip galv.
M6-B	Ø 8 a 11	66	49	12,7	2	
M6-C	Ø 9 a 15	68	65	12,7	4	
M6-D	Ø 8 a 11	57	50	9,5	4	
M6-E	Ø 3,5 a 7	42	32	7,9	4	

Alternativa B en Bce. para conductores de cobre.  
(Alternative B in Bronze for copper conductor)

**MATERIAL PARA PUESTA A TIERRA  
(FITTING FOR GROUND WIRE)**

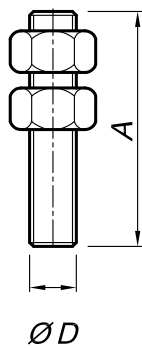
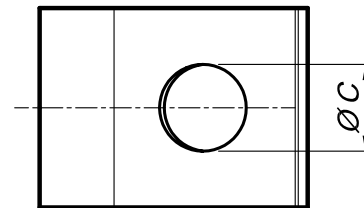

Fig.1



Fig.2



Modelo (Model)	Dimensiones (Dimensions) mm					Material (Material)
	Alcance (Range)	A	ØC	ØD	Fig.	
B-2	-	51	-	12,7	1	Ac. SAE 1010 Galv. en caliente
B-3	-	76	-	12,7	1	
M7-A	Ø 6 a 8	-	14	-	2	Steel SAE 1010 Hot dip galv.
M7-A-17	Ø 6 a 8	-	17	-	2	
M7-B	Ø 9 a 11	-	14	-	2	
M7-B-20	Ø 9 a 11	-	20	-	2	

Alternativa en Bce. o Cu. para conductores de cobre.  
(Alternative in Bronze or Cu.)